

ChemResist

ROTATIONAL-LINING

Premium linings for all
industrial fields

Rudolf Gutbrod GmbH

MANY YEARS OF EXPERIENCE WITH ChemResist

Rudolf Gutbrod GmbH sets standards early on as one of the leading fluoropolymer processors in Europe. Customer orientation is given a major priority at Rudolf Gutbrod GmbH. Many years of practical experience, consistent development of new technologies and a cooperation marked by flexibility, open-mindedness and commitment are also just as important for Rudolf Gutbrod GmbH.

Rudolf Gutbrod GmbH is a pioneer in lining technology with its innovative and economic product "ChemResist Rotational Sinter Lining".

Quite often the conventional lining and coating technologies available in the market do not fulfil the many requirements placed on them.

ChemResist puts a new emphasis in this case using a process and computer-controlled lining technology according to the rotational sinter lining process. This procedure creates a seamless lining with virtually uniform lining thickness.

High-quality fluorinated materials like ETFE, PFA and the Thermoplast PE, are used by ChemResist.

PERFECT SOLUTION FOR
SINTER LINING PROJECTS

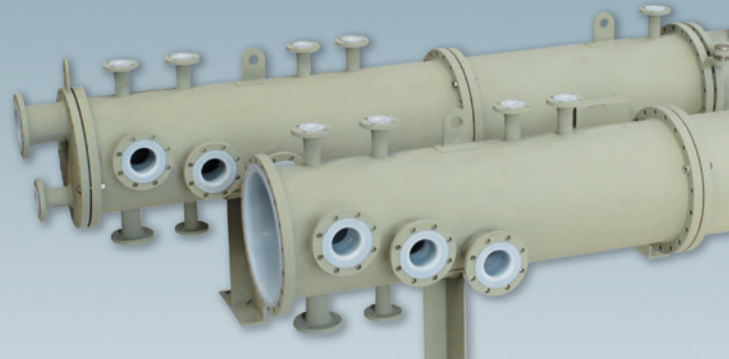

ETFE and PE are also available as electrically conducting versions. ChemResist ETFE is FDA- and EU-conform. This also applies to electrically conductive specifications.

Partly and fully fluorinated polymers offer universal and permanent resistance to acids, alkalis, solvents and chlorides. ChemResist possesses an extremely smooth and anti-adhesive surface and thus prevents bacterial adherence or growth.

In the manufacture of highly pure products (chip industry, high purity grade chemicals) ChemResist prevents impaired quality from foreign substances or dissolved metallic ions.

If special parts are to be lined, ChemResist possesses distinct advantages both from an economic as well as a qualitative point of view. The process can be adapted flexibly to the circumstances or requirements (preparation of tooling is not required). Even rigid construction specifications can be solved economically with ChemResist.



Mechanical preliminary work, as well as the use of adhesives, can be avoided. Chemical resistance and high temperature resilience remain unaffected. The permanent and homogeneous lamination to the substrate means new and interesting perspectives in use under vacuum.

ChemResist opens up new and versatile options for surface protection in almost all areas of industry to the user and the planning engineer.

ROTATIONAL SINTER LINING APPLICATIONS HAVE BEEN USED SUCCESSFULLY FOR 25 YEARS

Chemical and pharmaceutical industry

Reactors and column plates, pipe-work, reduction adapters, vessels, tanks, valves, cylinders, filters, pump casings, vibration filters, centrifuge casings, filters, galvanizing baths, etc.

Foodstuffs industry

Hoppers, pipe-work, vessels, etc.

Semi-conductor technology

Pure water tanks, vessels for highly purified chemicals, exhaust air ventilation systems, solar energy, semi-conductor technology, etc.

PERFECT SOLUTION FOR SINTER LINING PROJECTS

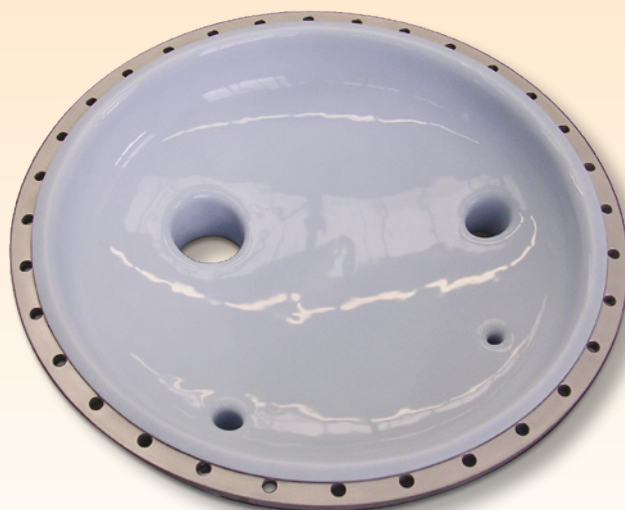

HOW DOES ROTATIONAL SINTER LINING WORK?

Rotational sinter lining is carried out by filling ultra-pure thermoplastic granulate (with good flowing properties) into the hollow body, pipe or vessel to be lined. The object holder is heated and turned bi-axially so that a uniform layer thickness of molten granulate is applied seamlessly to the inner surface of the component.

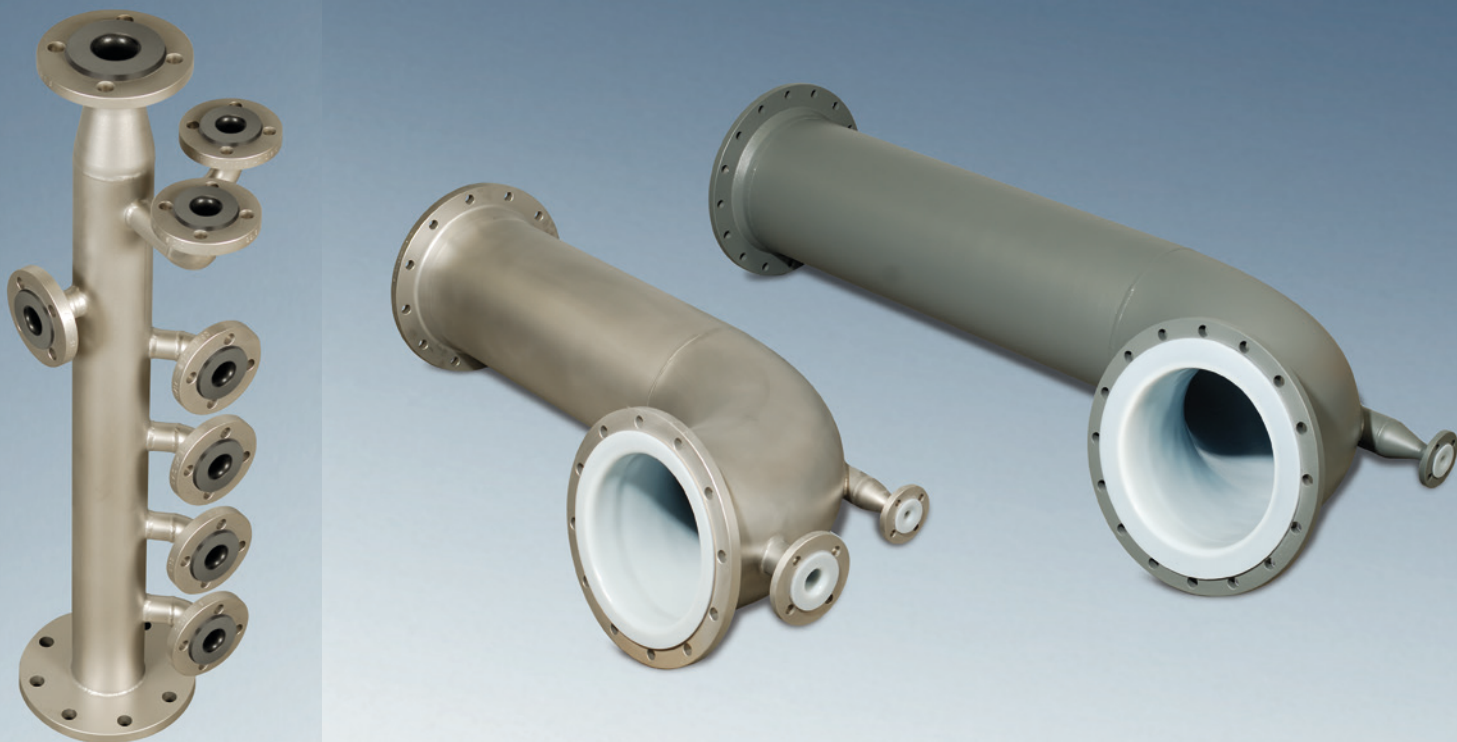
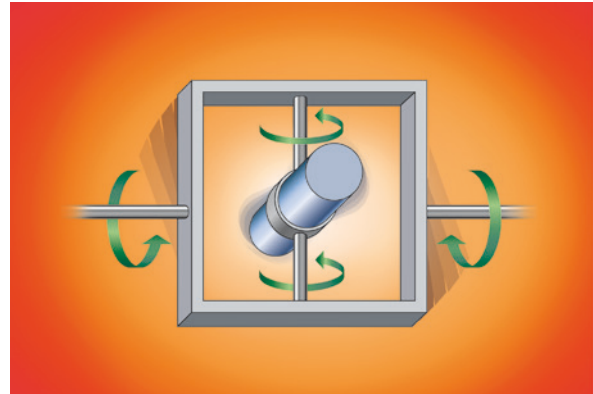

SATISFIED CUSTOMERS WHO TRUST IN GUTBROD

AllessaChemie
BASF Ludwigshafen
BASF PharmaChemikalien
BASF Rudolstadt
BASF Schwarzheide
Bayer CropScience
Bayer HealthCare
Bayer MaterialScience
Bayer Schering
Bayer Technology Services
Biochemie
Boehringer

Borealis
Cabot
Clariant
Dow Rheinmünster
DSM
Dynamit Nobel
DyStar
Endress + Hauser
Evonik
Fluorchemie Dohna
Haldor Topsoe
Hoffmann-La Roche

Ineos
Infineon
Jungbunzlauer
KataLeuna
Kemira
Krohne
Lanxess
Lenzing AG
Merck
Momentive
OMV
PCK

Robert Bosch GmbH
Sachtleben Chemie
Saltigo
Sandoz
Sanofi
Siltronic
Tectrion
Uhde
Vinnolit
Wacker Chemie

PROCESS SEQUENCE

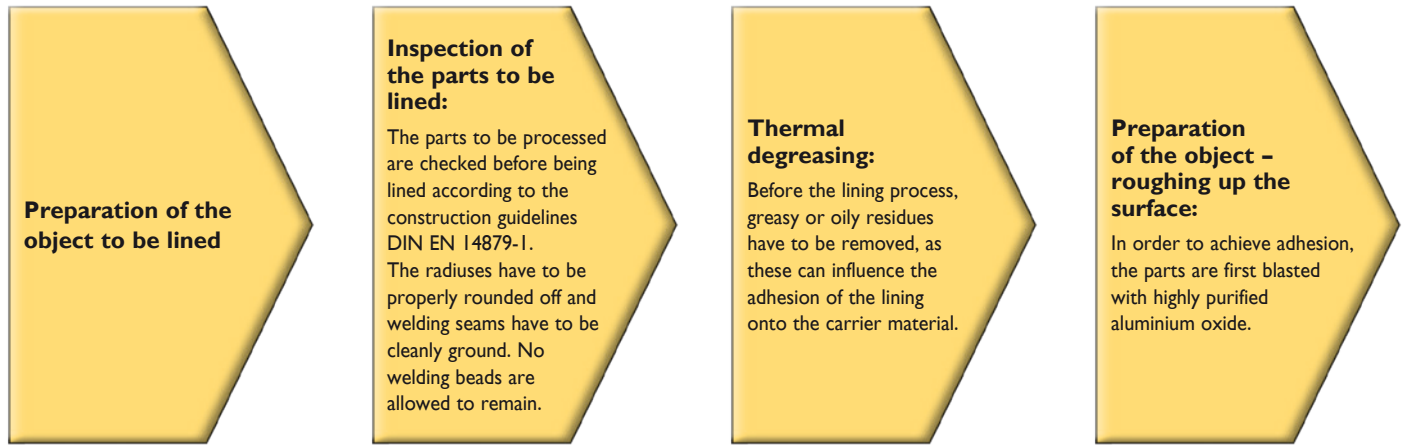

DECISIVE ADVANTAGES OF ChemResist WITH

Layer thicknesses up to 5 mm are possible

In conventional coating of components, the layer thickness is limited to approx. 1 mm. With the Gutbrod "ChemResist" system, wall thicknesses of up to 5 mm can be achieved.

Seamless lining

Complex and difficult parts do not represent a problem for ChemResist. All surfaces of the workpiece are reliably lined with specific biaxial movements. The result is a perfect and homogeneous lining without seams and welding points.

Reduced residual tension

As no pressure is required during the lining process, considerably less tension remains in the workpiece.

Optimally adhering coating

ChemResist requires no adhesive, and no joints are produced either. The permanent and homogeneous lamination to the substrate means new and interesting perspectives in use under vacuum. For special applications in the high temperature range, a very thin primer may be used.



Rotational sinter lining:

The components are fixed into a clamping device and filled with the appropriate material.

The lining temperature and rotational speed are individually set.

Finishing:

Mechanical processing of the sealed surface.

Inspection and quality control:

The components are inspected visually for appearance, layer thickness, pore impermeability and, if necessary, electrical conductivity, an inspection certificate 3.1 according to DIN EN 10204 is issued. All test procedures are documented.

Packaging and shipment

THE MATERIALS ETFE AND PE

Small lot sizes are also economical

It is also possible to complete small lot sizes economically using the technical rotation technology, even if there is a broad spectrum of complex forms and sizes.

Cost-effective despite quality improvement

The steel construction can be planned considerably more cost-effectively. By reducing the flange connectors (and thereby the number of potential leakage points), quality can be increased considerably.

Long-term safety

Homogeneous and permanent lamination to the substrate is achieved without the danger of collapsing with larger diameters. No safety risk through impact and longitudinal expansion, even at temperatures less than 0° C.

Quality assurance in every dimension

ChemResist permits components to be lined regardless of the design up to a size of 5,000 mm in length, a diameter of up to 3,500 mm and a total weight of 3,500 kg, without rigid requirements on the construction itself, larger and heavier parts on demand. The process sequence with entry and processing data is documented in detail.



COMPARISON WITH CONVENTIONAL COATING AND LINING PROCESSES

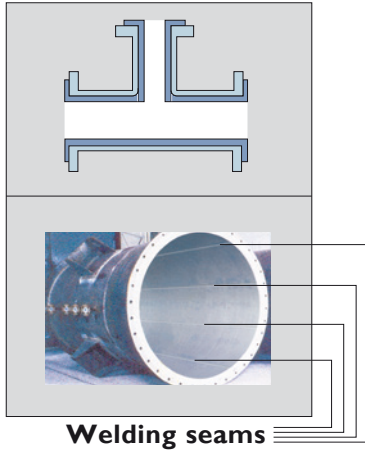

Electrostatic spray coating

E-CTFE, PFA, FEP, ETFE

Primer

Metal

- Thickness: approx. 1 mm
- Primer principle
- Several heating phases required

Loose lining

PTFE, PFA

Welding seam

Metal

- Thickness: from 2 mm
- Ventilation holes are necessary
- Only simple forms are possible
- For complicated parts (tanks) loose linings have to be welded

Conventional lining

PTFE, PFA, E-CTFE

Welding seam

Adhesive

Metal

- Reduced temperature resistance due to the use of adhesives
- Subsequent welding of joints is necessary



Effect of Temperature on Tensile Strength

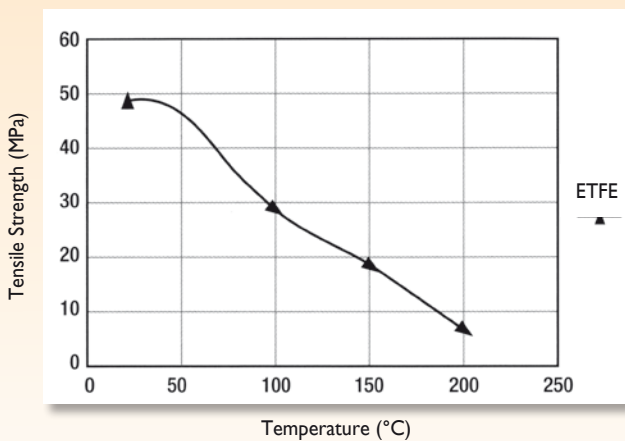

Effect of Temperature on Tensile Elongation

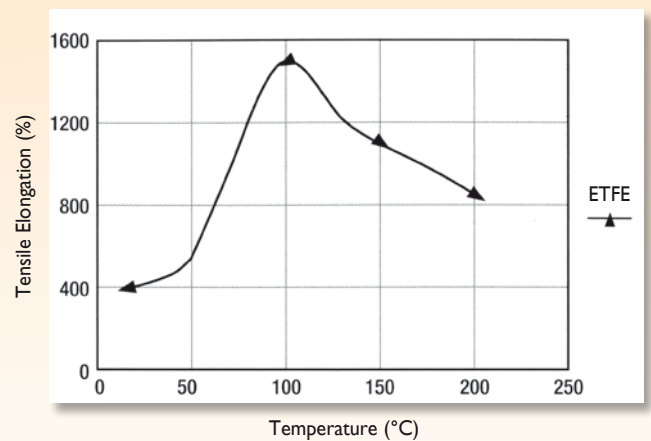

PERFECT SOLUTIONS WITH ChemResist ROTATIONAL SINTER LINING

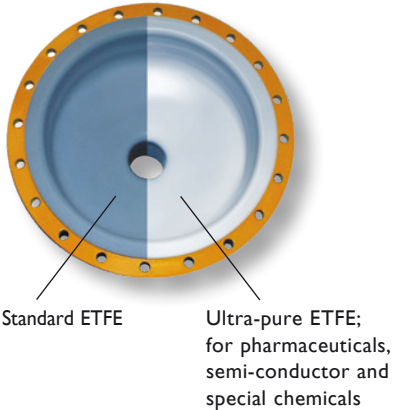

ETFE, PFA and PE Rotational sinter lining

ETFE, PFA and PE
Metal

- Thickness: 2 – 5 mm
- Direct laminate with metal
- Only one heating phase
- Seamless lining

ChemResist ROTATIONAL-LINING

**Seamless lining -
No welding seams -
No adhesives**



Effect of Temperature on Flexural Strength

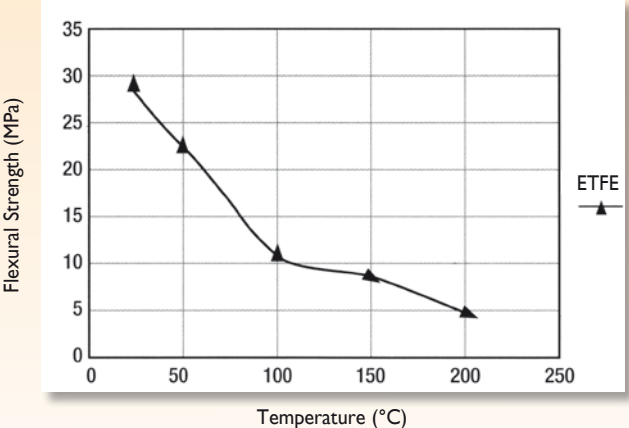

Effect of Temperature on Flexural Modulus

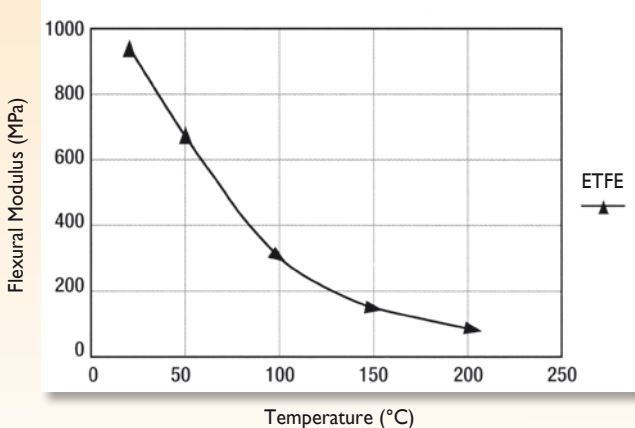

ChemResist

ROTATIONAL-LINING

ETFE, PFA AND PE HAVE MANY EXCELLENT PROPERTIES

Reduction of costs
Reduction of leakage points
Reduction of weight

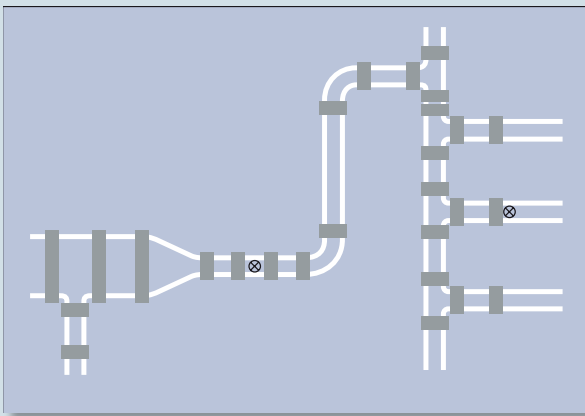

Conventional lining/ coating

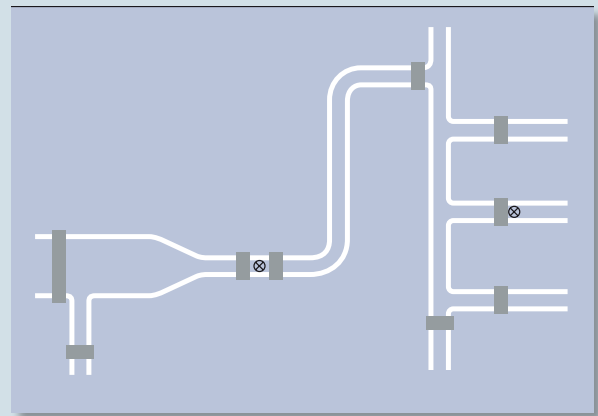

ChemResist Rotational Sinter Lining

- Exceptional, universal chemical resistance at high temperatures (ETFE, PFA)
- Purity
- No tension cracking
- Electrical conductivity (ETFE, PE)
- Repairable
- Solvent resistance
- Easy to clean, thanks to anti-adhesive surface (ETFE, PFA)
- FDA- and EU-conformity (ETFE)
- Non flammable (ETFE)
- Resistant to cold
- More robust
- Approved according to the Code of Practice Air (ETFE)

QUALITY WITHOUT COMPROMISES – BEST QUALITY FOR THE HIGHEST RELIABILITY

Extensive control checks of raw materials as well as continuous testing under operating conditions, constant quality controls and permanent improvements in production methods belong to the quality management activities at Rudolf Gutbrod GmbH, in order to ensure optimal working reliability during use in practice.

Thus, for example, the non-porosity of the coating is ensured by checking the finished final layer for pore density after completing the layer structure.

Furthermore, we ensure proper coating build-up according to the DIN EN 14879-1.

The interplay between our know-how, the modern facilities and equipment as well as our motivated and qualified specialists creates immaculate quality to satisfy the highest requirements.



IMMACULATE AND ECOLOGICALLY MINDED

Our responsibility for people and the environment means that we make sure to avoid environmental pollution, to use resources sparingly, and to achieve maximum energy efficiency, in accordance with ISO 14001:2015 and ISO 50001-2018.



BEST POSSIBLE PROPERTIES –
HIGHEST LEVEL OF COMPETENCY

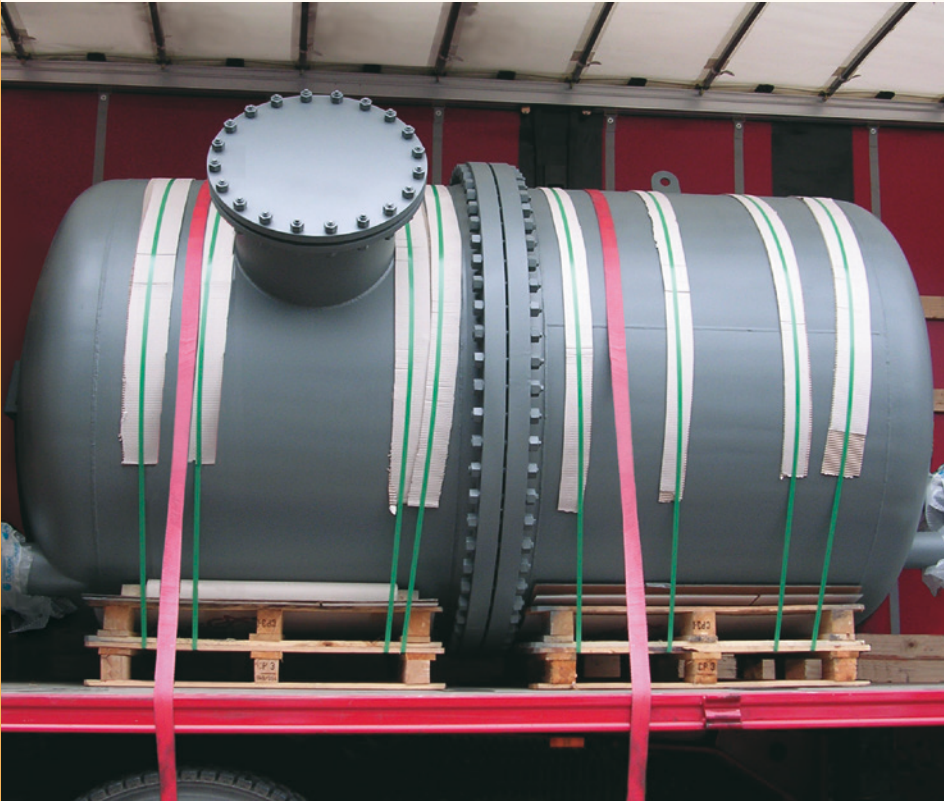

COMPETENT IN ALL ASPECTS ...

In order to survive in today's competitive environment we offer our customers not only perfect lining solutions, but also completely integrated concepts.

Optimal results emerge right from the start. You can count on our full-service consultancy competence from the very beginning.

TYPICAL PROPERTIES OF FLUOURINATED PLASTICS

Items		Units	ETFE tetra- fluoroethylene- ethylene- copolymer	FEP tetrafluoroethylene- hexafluoropropylene- copolymer	PCTFE polychloro- trifluoro- ethylene	PVDF polyvinylidene- fluoride	PTFE polytetra- fluoro- ethylene	ASTM No
Physical properties	Specific gravity		1.73 - 1.75	2.15 - 2.17	2.1 - 2.2	1.76 - 1.77	2.1 - 2.2	D792
	Melting point	°C	265 - 270	285 - 295	212 - 217	170 - 185	327	
	Melt viscosity	poise (°C)	10 ⁴ - 10 ⁵ (300 - 330)	10 ⁴ - 10 ⁵ (350 - 380)	3× 10 ⁶ - 2× 10 ⁷ (270 - 300)	3× 10 ⁶ - 2× 10 ⁷ (270 - 300)	10 ⁴ - 10 ⁵ (300 - 300)	
Mechanical properties	Tensile strength 23°C	kg/cm ²	410 - 470	190 - 220	300 - 400	500 - 600	70 - 280	JIS K689
	Yield strength 23°C	kg/cm ²	190 - 220	130 - 150	400 - 450	400 - 600	120 - 160	JIS K689I
	Elongation 23°C	%	420 - 440	250 - 330	80 - 250	200 - 300	225 - 600	JIS K689I
	Tensile modulus	kg/cm ²	5 - 8× 10 ³	3.5× 10 ³	10 - 20× 10 ³	8 - 14× 10 ³	4× 10 ³	D638
	Flexural modulus	kg/cm ²	9 - 10× 10 ³	6.7× 10 ³	17.6× 10 ³	14 - 18× 10 ³	3.5 - 6.3× 10 ³	D790
	Izod impact strength	ft-lb/in notch	no break	no break	3.0	3.5 - 3.8	3.0	D256
	Rockwell hardness		R-50	R-25	R-75 - 95	R-110	R-18	D785
Thermal properties	Frictional coeff. (against stainl. steel)		0.20	0.20	0.18	0.21	0.09	
	Linear thermal expansion coeff.	°C ⁻¹	9.4× 10 ⁻⁵	9× 10 ⁻⁵	10× 10 ⁻⁵	12 - 15× 10 ⁻⁵	10× 10 ⁻⁵	D696
	Flammability		Incombustible	Incombustible	Incombustible	Self-extinguish	Incombustible	D635
Chemical properties	Continuous Service temperature	°C	150	220	180	150	260	
	Chemical resistance		Excellent	Excellent	Good	Good	Excellent	D543
	Water absorption 23°C	%	0.01>	0.01>	0.00	0.34 - 0.04	0.01>	D570
	Permeation (O ₂)	cc.mil/ 100 in ² 24 hr • atm	148	300 - 900	4 - 90	3.3 - 4.0	1050	D1434
Electrical properties	(N ₂)		45	150 - 170	1.5 - 22	0.9 - 2.1	390	D143
	Volume specific resistance	ohm/cm	10 ¹⁷	10 ¹⁸	1.4× 10 ¹⁷	2 - 6× 10 ¹⁷	10 ¹⁸	D257
	Dielectric constant tangent 23°C		2.4 - 2.6	2.1	2.5 - 2.8	3 - 11	2.1	D150
	Dielectric loss tangent 23°C	60 H ₂ 10 ³ H ₂ 10 ⁶ H ₂ 10 ⁹ H ₂	0.0001> 0.0005 0.0032 0.01	0.0003 0.0002 0.0007 0.0005	0.015 0.023 0.012 0.01	0.05 0.018 0.16 0.11	0.0001> 0.0001> 0.0001> 0.0004	D150 D150 D150 D150
	Breakdown voltage (short time)	KV/0.1 mm film	12	12	12 - 13	9	8 - 10	JIS K689I
Arc resistance	sec	120	165<	300<	50 - 70	300<	D495	

... EVEN COMPLETE SOLUTIONS

Start talking to us already in the planning phase. We shall be pleased to provide complete solutions and will take over the responsibility for your steel construction, in collaboration with our competent and certified partners.

With our own jig manufacturing (mounting objects up to 3,500 kg, heavier parts on demand), modern means of production and facilities we produce according to state-of-the-art technology standards.

Our quality-management is certified in accordance to DIN EN ISO 9001:2015. We shall also continue to invest in new means of production in the future.

CHEMICAL PROTECTION AT HIGHEST LEVEL,
WITH VERY BEST PERMEATION PROPERTIES

ChemResist ETFE ultra⁺ EVOLUTION – a product of our line ultra⁺

The material for this Fluoropolymer-Coating, that will be applied by the Rotational-Sinter-Lining-Technology is highly resistant against chemicals and acids, and has extraordinarily advantages, compared with common coating and lining systems:

- Fully automated Rotational-Sinter-Lining-Technology for highest demands
- Seamless lining for almost all designs
- Excellent bonding to substrate
- Compared with conventional Fluoropolymer-Linings outstanding features in permeation by using filler
- Layer thickness up to 5 mm

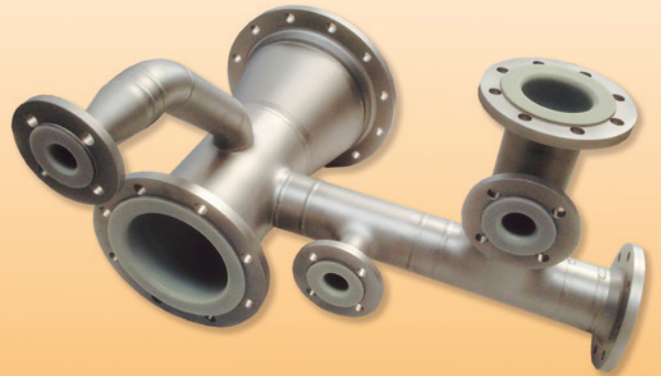

ChemResist ETFE ultra⁺ EVOLUTION

- Exceptional, universal chemical resistance at high temperatures
- Excellent when proven under clean room conditions
- Also available in electrical conductive version
- Locally repairable
- Solvent-resistant
- Easy to clean, excellent non-stick properties
- Non flammable
- Cold resistant
- Suitable for vacuum
- FDA- and EU-compliant

CHEMICAL PROTECTION AT HIGHEST LEVEL AND WITH VERY BEST PERMEATION PROPERTIES, ESPECIALLY WHEN HIGHER TEMPERATURE LOAD IS GIVEN!

ChemResist PFA ultra⁺ EVOLUTION – a product of our line ultra⁺

The material for this Fluoropolymer-coating, that will be applied with the Rotational-Sinter-Lining-Technology is highly resistant against chemicals and acids, and has extraordinarily advantages, compared with common coating and lining systems:

- Fully automated Rotational-Sinter-Lining-Technology for highest demands
- Seamless lining for almost all designs
- Excellent bonding to substrate
- Compared with conventional Fluoropolymer-Linings outstanding features in permeation by using filler
- Layer thickness up to ~4 mm (depending on the shape of the part)

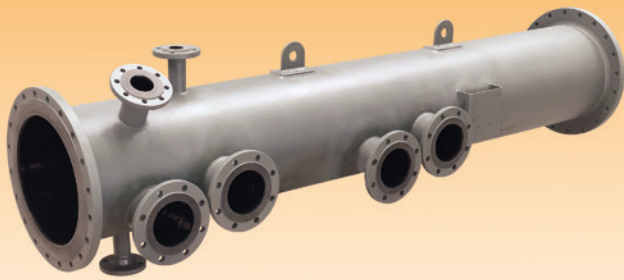

ChemResist PFA ultra⁺ EVOLUTION

- Exceptional, universal chemical resistance, specially appropriated at high temperature load
- Locally repairable
- Solvent-resistant
- Easy to clean, excellent non-stick properties
- Non flammable
- Cold resistant
- Suitable for vacuum
- FDA- and EU-compliant

THE RUDOLF GUTBROD COMPANY: PIONEER OF SURFACE TECHNOLOGY

Rudolf Gutbrod GmbH in Swabian Dettingen/Erms continues to set new standards in innovative coating technology. The company is leading in Europe as a processor of fluorinated polymers.

The enterprise was founded in 1964 and is a pioneer in Germany in surface coating technology with fluoropolymers. It is also a licensee in Europe of well-known raw material manufacturers and is one of Europe's top addresses as far as func-

tional coatings with non-stick effect, low friction, chemical protection and corrosion protection are concerned. State-of-the-art technology is ensured through continuous development work.



Our responsibility for people and the environment means that we make sure to avoid environmental pollution, to use resources sparingly, and to achieve maximum energy efficiency, in accordance with ISO 14001:2015 and ISO 50001-2018.

Raw material procurement is undertaken on a worldwide basis. International and permanent exchange of ideas will also ensure in the future that the highest possible quality will be maintained in solving the different requirements of our customers.





Industrie Service

Choose certainty.
Add value.

Inspection/certification of the ChemResist® ETFE fluoroplastic lining system from Rudolf Gutbrod GmbH under application of thermal stress and vacuum

Customer:	Rudolf Gutbrod GmbH, Im Schwöllbogen 10, 72581 Dettingen/Erms, Germany
Order:	Order dated 14 January 2011
Order number:	600 115 575
Subject of the inspection:	Inspection of the ChemResist® ETFE lining, applied to a column section (DN = 1000 mm, height = 1000 mm) with two flat covers
Preparation of the column section before application of the lining:	Column section thermally degreased at 430 °C, then sand-blasted with aluminium oxide
Inspection conditions:	Column section temperature 150 °C; pressure 25 mbar absolute (external overpressure approx. 1 bar); stress period 125 hours (> 5 days)
Start of inspection:	21 th January 2011
End of inspection:	26 th January 2011
Evaluation:	1 st February 2011
State of lining before inspection:	Thickness on container 3.6 to 4.2 mm (Ø 4.1 mm); thickness on cover 3.6 to 4.7 mm (Ø 4.2 mm), thickness on base 3.8 to 4.3 mm (Ø 4.0 mm). The lining was bubble-free and exhibited no signs of contamination or external influences. The cover and base were sealed against the mechanically-processed flange using PTFE sealing tape (10 x 3.0 mm). The cover and base were each fastened with 28 screws, with a torque of 220 Nm applied to each screw.
Inspection run:	Two thermal elements were attached to the container for measuring the container temperature (steel body) and ambient temperature, and were connected to measuring devices. A metal hose was connected to the vacuum pump and a digital manometer through a flange in the cover.

Date: 2011-02-01

Our reference:
IS-ATA5-STG/Ernst

Document:
Rudolf Gutbrod 600 115 575
ETFE Auskleidung englisch.doc

Report No. 600 115 575

This document consists of
2 Pages.
Page 1 of 2

Excerpts from this document may
only be reproduced and used for
advertising purposes with the
express written approval of
TÜV SÜD Industrie Service GmbH.

The text results refer exclusively
to the units under test.



After application of an absolute vacuum of 25 mbar, the entire container was placed in a convection oven. The screw connections were retightened after one hour. With applied vacuum, the column section was then heated to 150 °C in the convection oven. The column temperature was reached after 5 hours and then maintained at 150 °C.

Temperature measurement:	Two temperature data loggers – Testo 735-1 and 735-2 (new devices with factory calibration; accuracy ± 0.2 K). A thermal element was inserted into each bore on the flange in order to measure the column section temperature.
Pressure measurement:	Membranovac DM 12 with D/2000 sensor (new device with factory calibration; measurement uncertainty 0.5% from measured value)
Duration of inspection:	The inspection conditions were maintained for 125 hours and recorded for documentation (column section temperature 150 °C; pressure 25 mbar absolute (external overpressure ca. 1 bar); stress period 125 hours (> 5 days)).
State of lining after inspection:	No changes were detected as compared to the new condition before the inspection. In particular, there were no bubbles, cracks or lining detachment, etc.

Inspection results:

Under inspection conditions, the lining exhibited no changes as compared to the new condition.

As such, ChemResist® ETFE fluoroplastic lining meets the following requirements:

- Object temperature 150 °C
- Vacuum 25 mbar absolute
- Stress period of 5 days

Chemical resistance against media was not a part of this inspection.

Filderstadt, 1st February 2011

Authorised assessor



Bernd Emst



Region Baden-Württemberg
Bereich Anlagentechnik
Institut für Kunststoffe



RUDOLF GUTBROD GmbH

Im Schwöllbogen 10

72581 Dettingen/Erms

Germany

Tel. +49(0)71 23 - 97 35-0

www.gutbrod-ptfe.de

info@gutbrod-ptfe.de